



MGS-250

Infrared Gas Detector

Installation and Operation Manual
Instruction 6490-9000
February 2014
Revision 1



Product Leadership • Training • Service • Reliability

WARRANTY POLICY

BACHARACH, INC. WARRANTS THIS GAS DETECTOR TO BE FREE FROM DEFECTS IN MATERIALS AND WORKMANSHIP FOR A PERIOD OF ONE YEAR FROM THE DATE OF PURCHASE BY THE ORIGINAL OWNER. IF THE PRODUCT SHOULD BECOME DEFECTIVE WITHIN THIS WARRANTY PERIOD, WE WILL REPAIR OR REPLACE IT AT OUR DISCRETION.

THE WARRANTY STATUS MAY BE AFFECTED IF THE GAS DETECTOR HAS NOT BEEN USED AND MAINTAINED PER THE INSTRUCTIONS IN THIS MANUAL OR HAS BEEN ABUSED, DAMAGED, OR MODIFIED IN ANY WAY. THIS GAS DETECTOR IS ONLY TO BE USED FOR PURPOSES STATED HEREIN. THE MANUFACTURER IS NOT LIABLE FOR AUXILIARY INTERFACED EQUIPMENT OR CONSEQUENTIAL DAMAGE.

DUE TO ONGOING RESEARCH, DEVELOPMENT, AND PRODUCT TESTING, THE MANUFACTURER RESERVES THE RIGHT TO CHANGE SPECIFICATIONS WITHOUT NOTICE. THE INFORMATION CONTAINED HEREIN IS BASED ON DATA CONSIDERED ACCURATE. HOWEVER, NO WARRANTY IS EXPRESSED OR IMPLIED REGARDING THE ACCURACY OF THIS DATA.

ALL GOODS MUST BE SHIPPED TO THE MANUFACTURER BY PREPAID FREIGHT. ALL RETURNED GOODS MUST BE PRE-AUTHORIZED BY OBTAINING A RETURN MERCHANDISE AUTHORIZATION (RMA) NUMBER. CONTACT THE MANUFACTURER FOR A NUMBER AND PROCEDURES REQUIRED FOR PRODUCT TRANSPORT.

SERVICE POLICY

BACHARACH, INC. AND MURCO MAINTAIN SERVICE FACILITY AT THEIR RESPECTIVE FACTORIES. SOME DISTRIBUTORS / AGENTS MAY ALSO HAVE REPAIR FACILITIES, HOWEVER, BACHARACH AND MURCO ASSUME NO LIABILITY FOR SERVICE PERFORMED BY ANYONE OTHER THAN BACHARACH OR MURCO PERSONNEL. REPAIRS ARE WARRANTED FOR 90 DAYS AFTER DATE OF SHIPMENT (SENSORS, PUMPS, FILTERS AND BATTERIES HAVE INDIVIDUAL WARRANTIES). SHOULD YOUR GAS DETECTOR REQUIRE NON-WARRANTY REPAIR, YOU MAY CONTACT THE DISTRIBUTOR FROM WHOM IT WAS PURCHASED OR YOU MAY CONTACT BACHARACH OR MURCO DIRECTLY.

IF BACHARACH OR MURCO IS TO DO THE REPAIR WORK, SEND THE GAS DETECTOR, PREPAID, TO THE APPROPRIATE ADDRESS BELOW.

BACHARACH, INC.
621 HUNT VALLEY CIRCLE
NEW KENSINGTON, PA 15068
ATTENTION: SERVICE DEPT

MURCO - A BACHARACH COMPANY
114A GEORGES STREET LOWER
DUN LAOGHAIRE
CO DUBLIN IRELAND

ALWAYS INCLUDE YOUR RMA #, ADDRESS, TELEPHONE NUMBER, CONTACT NAME, SHIPPING/BILLING INFORMATION AND A DESCRIPTION OF THE DEFECT AS YOU PERCEIVE IT. YOU WILL BE CONTACTED WITH A COST ESTIMATE FOR EXPECTED REPAIRS PRIOR TO THE PERFORMANCE OF ANY SERVICE WORK. FOR LIABILITY REASONS, BACHARACH AND MURCO HAVE A

POLICY OF PERFORMING ALL NEEDED REPAIRS TO RESTORE THE GAS DETECTOR TO FULL OPERATING CONDITION.

PRIOR TO SHIPPING EQUIPMENT TO BACHARACH OR MURCO, CONTACT OUR OFFICE FOR AN RMA # (RETURN MERCHANDISE AUTHORIZATION). ALL RETURNED GOODS **MUST** BE ACCOMPANIED BY AN RMA NUMBER.

PACK THE EQUIPMENT WELL (IN ITS ORIGINAL PACKING IF POSSIBLE), AS BACHARACH CANNOT BE HELD RESPONSIBLE FOR ANY DAMAGE INCURRED DURING SHIPPING TO OUR FACILITY.

NOTICES

COPYRIGHTS: THIS MANUAL IS SUBJECT TO COPYRIGHT PROTECTION; ALL RIGHTS ARE RESERVED UNDER INTERNATIONAL AND DOMESTIC COPYRIGHT LAWS. THIS MANUAL MAY NOT BE COPIED OR TRANSLATED, IN WHOLE OR IN PART, IN ANY MANNER OR FORMAT, WITHOUT THE WRITTEN PERMISSION OF BACHARACH, INC.

ALL SOFTWARE WHICH BACHARACH UTILIZES AND/OR DISTRIBUTES, HOLDS A PROPRIETARY INTEREST AND IS ALSO SUBJECT TO COPYRIGHT PROTECTION AND ALL RIGHTS ARE RESERVED. NO PARTY MAY USE OR COPY SUCH SOFTWARE IN ANY MANNER OR FORMAT, EXCEPT TO THE EXTENT THAT BACHARACH GRANTS THEM A LICENSE TO DO SO. IF THIS SOFTWARE IS BEING LOADED ONTO MORE THAN ONE COMPUTER, EXTRA SOFTWARE LICENSES MUST BE PURCHASED.

TECHNICIAN USE ONLY

THIS UNIT MUST BE INSTALLED BY A QUALIFIED TECHNICIAN WHO WILL INSTALL THIS UNIT IN ACCORDANCE WITH THESE INSTRUCTIONS AND THE STANDARDS IN THEIR PARTICULAR INDUSTRY/COUNTRY. OPERATORS OF THE UNIT SHOULD BE AWARE OF THE REGULATIONS AND STANDARDS IN THEIR INDUSTRY/COUNTRY FOR THE OPERATION OF THIS UNIT. THESE NOTES ARE ONLY INTENDED AS A GUIDE, AND THE MANUFACTURER BEARS NO RESPONSIBILITY FOR THE INSTALLATION OR OPERATION OF THIS UNIT.

FAILURE TO INSTALL AND OPERATE THE UNIT IN ACCORDANCE WITH THESE INSTRUCTIONS AND WITH INDUSTRY GUIDELINES MAY CAUSE SERIOUS INJURY INCLUDING DEATH, AND THE MANUFACTURER WILL NOT BE HELD RESPONSIBLE IN THIS REGARD.

Table of Contents

SECTION 1. INTRODUCTION	9
1.1. Overview	9
1.2. Detection Options	10
1.2.1. Broadband vs. Gas Specific	10
1.2.2. Broadband Gas Detection	10
1.2.3. Detecting Specific Gases	11
1.3. Remote Controller Options	15
1.4. Parts List	15
1.5. Specifications	16
SECTION 2. MOUNTING THE GAS DETECTOR	17
2.1. Warnings and Prerequisites	17
2.2. Mounting Locations	17
2.2.1. General Placement Guidelines	17
2.2.2. Machinery Rooms	18
2.2.3. Refrigerated Spaces	18
2.2.4. Chillers	19
2.3. Mounting Procedure	19
SECTION 3. WIRING AND CONFIGURATION	22
3.1. Overview	22
3.2. Wiring Supply Power (24VAC or 24VDC)	23
3.3. Wiring Alarm Output (Analog Signal)	25
3.4. Wiring the Digital Alarm Output Relay	26
3.5. Modbus Network Configuration	27
3.6. Conclusion	29
SECTION 4. OPERATION AND STABILIZATION	30
4.1. Power Up and Warmup	30
4.2. Stabilization	30
4.3. Perform a Manual Zero	30
4.4. Alarms	31
4.5. Gas Detector Faults	31
4.5.1. Overview	31
4.5.2. Non-Critical Faults	31
4.5.3. Critical Faults	32
SECTION 5. CONFIGURE THE GAS DETECTOR	33
5.1. User Interface Overview	33

- 5.2. Setting Parameters..... 34
 - 5.2.1. Overview 34
 - 5.2.2. Configuration Parameters..... 34
- 5.3. Completing Setup..... 42
- SECTION 6. FUNCTIONAL TESTS AND ADJUSTMENTS 43**
- 6.1. Introduction 43
- 6.2. Bump Testing vs. Adjusting Detector Response..... 44
- 6.3. Bump Testing 45
- 6.4. Adjustment Using Calibration Gas 46
- SECTION 7. MODBUS COMMUNICATIONS 49**
- 7.1. Introduction 49
- 7.2. Communications Settings 49
- 7.3. Analog Input Registers 50
- 7.4. Analog Output Registers 51
- 7.5. Input Status Flags 52
- 7.6. Output Status Flags 52
- SECTION 8. TROUBLESHOOTING 53**
- 8.1. Fault Codes..... 53
- 8.2. Diagnostics Attributes (P.-18) 55
- 8.3. Resetting MGS-250 to Default Values..... 56
- 8.4. Other Symptoms 57
- SECTION 9. REPLACEMENT PARTS AND ACCESSORIES..... 58**
- CE DECLARATION OF CONFORMITY 59**

List of Figures

SECTION 1. INTRODUCTION	9
Figure 1. MGS-250 Components	9
Figure 2. Broadband Gas Groups 1-3	11
Figure 3. Gas Specific MGS-250 Gas Detectors	12
Figure 4. Changing Gas Types and Accuracy	14
SECTION 2. MOUNTING THE GAS DETECTOR.....	17
Figure 5. Initial Housing Separation	20
Figure 6. Front and Back Views of MGS-250 Base	21
SECTION 3. WIRING AND CONFIGURATION.....	22
Figure 7. Terminal Blocks and Cable Glands	22
Figure 8. Supply Power Wiring Options	23
Figure 9. Maintaining Neutral Polarity.....	24
Figure 10. Analog Output Wiring	25
Figure 11. Sample Relay Output Wiring.....	26
Figure 12. Modbus Network Wiring.....	27
Figure 13. Setting Network Termination Resistors	29
SECTION 5. CONFIGURE THE GAS DETECTOR.....	33
Figure 14. The User Interface of the MGS-250	33
Figure 15. Analog Output Scaling Options	39
SECTION 6. FUNCTIONAL TESTS AND ADJUSTMENTS	43
Figure 16. Using Calibration Gas	46

List of Tables

SECTION 1. INTRODUCTION	9
Table 1: Broadband Gas Groups and Performance (P/N 6401-0500)	10
Table 2: Gas Specific Detector Measurement Performance	13
Table 3: Parts List	15
Table 4: Technical Specifications	16
SECTION 3. WIRING AND CONFIGURATION	22
Table 5: Power Options and Terminal Block Connections	23
Table 6: Alarm Output Terminal Block Connections	25
Table 7: Relay Output Terminal Block Connections	26
Table 8: Modbus Network Communications Connections	27
SECTION 4. OPERATION AND STABILIZATION	30
Table 9: MGS-250 Behavior during Alarm Conditions	31
Table 10: MGS-250 Behavior during a Non-Critical Fault	32
Table 11: MGS-250 Behavior during a Critical Fault	32
SECTION 5. CONFIGURE THE GAS DETECTOR	33
Table 12: Button Functions	33
Table 13: Parameter Numbers, Names and Descriptions	34
SECTION 7. MODBUS COMMUNICATIONS	49
Table 14: Analog Input Registers	50
Table 15: Analog Output Registers	51
Table 16: Input Status Flags	52
Table 17: Output Status Flags	52
SECTION 8. TROUBLESHOOTING	53
Table 18: Fault Codes	54
Table 19: Diagnostic Attributes	55
Table 20: Other Symptoms and Possible Causes	57
SECTION 9. REPLACEMENT PARTS AND ACCESSORIES	58
Table 21: Replacement Parts and Accessories	58

Section 1. Introduction

1.1. Overview

The MGS-250 NDIR (non-dispersive infrared) is a state-of-the-art fixed gas detector which can detect a wide range of refrigerant gases. The MGS-250 can be used on a stand-alone basis or integrated into controls or a Building Management System (BMS).

The MGS-250 can be used in locations that require continuous monitoring and to add gas detection solutions to an existing system.



Figure 1. MGS-250 Components

1.2. Detection Options

1.2.1. Broadband vs. Gas Specific

The MGS-250 NDIR refrigerant gas detectors are available in two versions: broadband and gas specific.

1.2.2. Broadband Gas Detection

The *broadband gas detector* (P/N 6401-0500) is used as a general purpose gross leak detector and is factory tested and certified. It is shipped from the factory with accuracy as shown in Table 1 (gas dependent). If more accurate detection is needed, gas specific versions are available, which are factory certified and calibrated to the target refrigerant.

The broadband gas detector combines refrigerants into three groups shown in Figure 2. Measurement performance is based on an *average response profile* for all of the gases within the group.



NOTE: Greater accuracy may be achieved through the use of calibration gas and the adjustment procedure detailed in Section 6.

Table 1: Broadband Gas Groups and Performance (P/N 6401-0500)

Group #	Value for Param 11 ¹	Refrigerant	As Shipped Accuracy
1	P.-11 = 1	R123	±30 ppm ±35%
		R134a	±30 ppm ±25%
		R404a	±30 ppm ±35%
		R407a	±30 ppm ±25%
		R407c	±30 ppm ±20%
		R407f	±30 ppm ±20%
		R410a	±30 ppm ±20%
		R427a	±30 ppm ±15%
2	P.-11 = 2	R507	±30 ppm ±35%
		R422a	±30 ppm ±25%
		R422d	±30 ppm ±20%
		HFO1234YF	±30 ppm ±25%
3	P.-11 = 3	HFO1234Ze	±30 ppm ±25%
		R22	±30 ppm ±25%

1 See Section 5 for information on Parameter 11 and other configuration instructions.

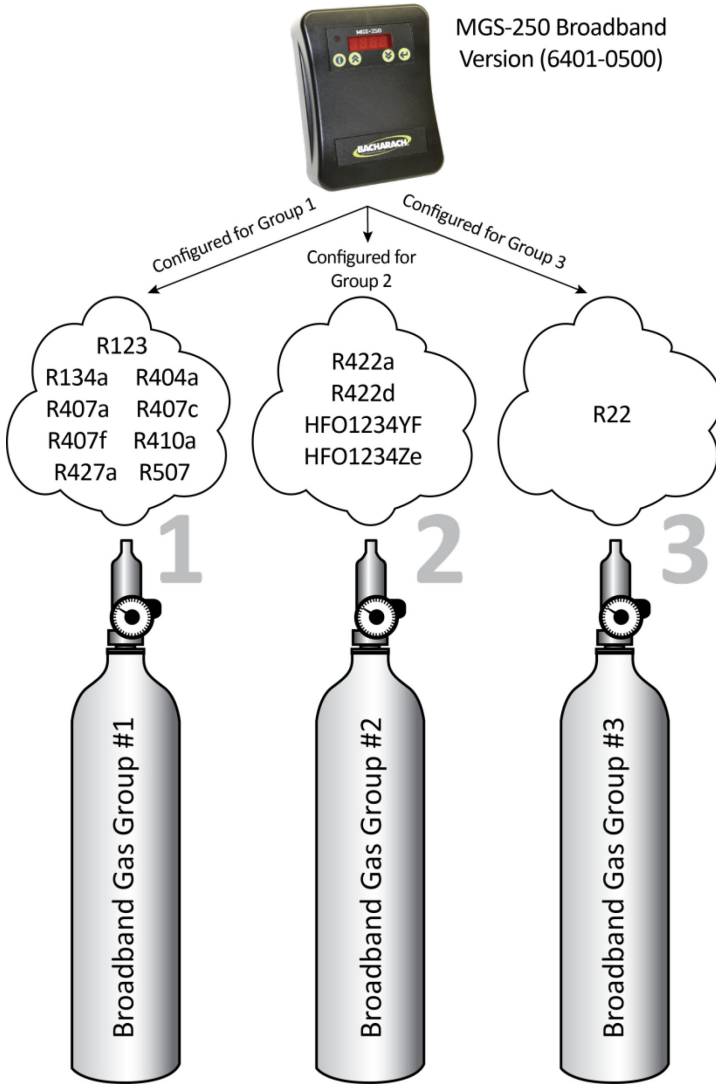

Figure 2. Broadband Gas Groups 1-3

1.2.3. Detecting Specific Gases

Each *gas-specific gas detector* (PNs 6401-0501 to 6401-0514) is shipped factory calibrated to its specific target refrigerant. Refer to Figure 3 and Table 2.

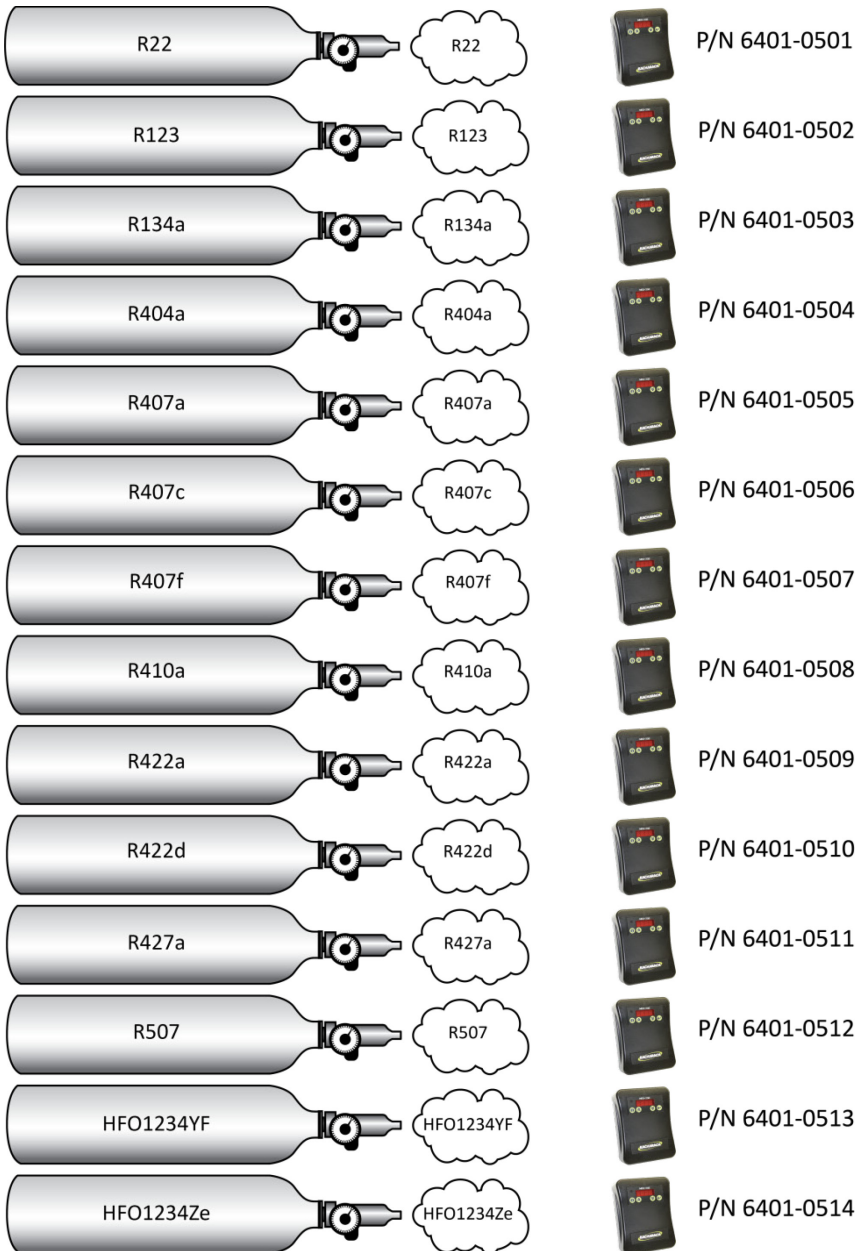

Figure 3. Gas Specific MGS-250 Gas Detectors

Table 2: Gas Specific Detector Measurement Performance

Part Number	Refrigerant ¹	Accuracy
6401-0501	R22	±30 ppm ±5%
6401-0502	R123	±30 ppm ±5%
6401-0503	R134a	±30 ppm ±5%
6401-0504	R404a	±30 ppm ±5%
6401-0505	R407a	±30 ppm ±3%
6401-0506	R407c	±30 ppm ±3%
6401-0507	R407f	±30 ppm ±3%
6401-0508	R410a	±30 ppm ±3%
6401-0509	R422a	±30 ppm ±5%
6401-0510	R422d	±30 ppm ±5%
6401-0511	R427a	±30 ppm ±3%
6401-0512	R507	±30 ppm ±5%
6401-0513	HFO1234YF	±30 ppm ±5%
6401-0514	HFO1234Ze	±30 ppm ±5%

¹ See Section 5 for information on Parameter 11 and other configuration instructions.



NOTE: Gas specific detectors can be re-calibrated in the field to new target gases. Use optional calibration instructions in Chapter 6 for increased accuracy when detecting a new target gas that is different from the “as shipped” target gas. Refer to the example in Figure 4.

<p style="writing-mode: vertical-rl; transform: rotate(180deg);">As Shipped</p>	 <p style="text-align: center;">R22</p> <p style="text-align: center;">$\pm 30 \text{ ppm } \pm 5\% \text{ of reading}$</p> <p>Part number 6401-0501 (R22) is factory calibrated to R22 and has an as-shipped R22 response accuracy of $\pm 30 \text{ ppm } \pm 5\%$ of reading.</p>
<p style="writing-mode: vertical-rl; transform: rotate(180deg);">Changed Gas Type (Reduced Accuracy)</p>	 <p style="text-align: center;">R134A</p> <p style="text-align: center;">$\pm 30 \text{ ppm } \pm 16\% \text{ of reading}$</p> <p>The gas detector may be changed to respond to any of the other listed refrigerants (see parameter P.-11, in section 5.2). If changed, the gas detector will have a lower accuracy for the target refrigerant (without calibration). In this example, that accuracy is $\pm 30 \text{ ppm } \pm 16\%$ of reading.</p>
<p style="writing-mode: vertical-rl; transform: rotate(180deg);">Optional Recalibration (For Improved Accuracy)</p>	 <p style="text-align: center;">R134A CALIBRATION GAS</p> <p style="text-align: center;">$\pm 30 \text{ ppm } \pm 5\% \text{ of reading}$</p> <p>By applying calibration gas containing the <i>new</i> target refrigerant, and via the routine described in Section 6.4, the gas detector may then be adjusted to respond with the calibrated accuracy of $\pm 30 \text{ ppm } \pm 5\%$ of reading as shown in Table 2 for the new target refrigerant.</p>

Figure 4. Changing Gas Types and Accuracy

1.3. Remote Controller Options

The MGS can connect to any controller through the standard analog output (voltage and current; see Table 4 for options), the standard alarm relay, or the digital Modbus RTU communications interface.

1.4. Parts List

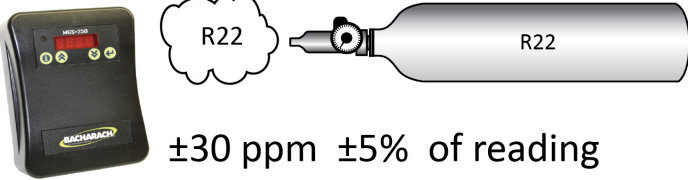
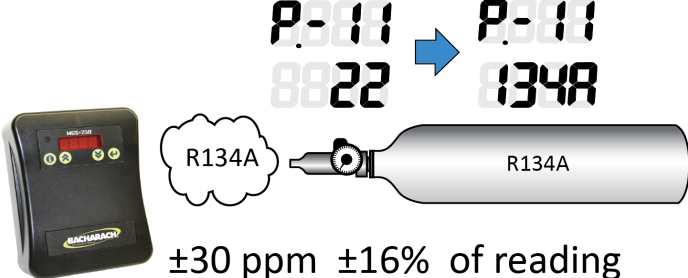
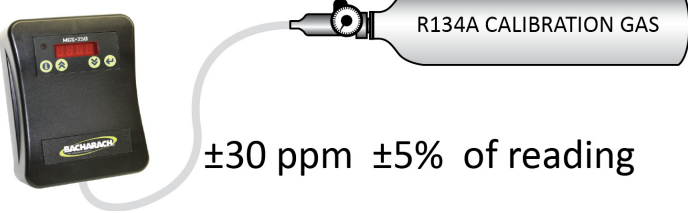
Table 3 shows a list of components that are shipped with your order.

Table 3: Parts List

Part Number		Description
Various (Depends on Model Ordered)	6401-0500	MGS-250, Broadband
	6401-0501	MGS-250, R22
	6401-0502	MGS-250, R123
	6401-0503	MGS-250, R134a
	6401-0504	MGS-250, R404a
	6401-0505	MGS-250, R407a
	6401-0506	MGS-250, R407c
	6401-0507	MGS-250, R407f
	6401-0508	MGS-250, R410a
	6401-0509	MGS-250, R422a
	6401-0510	MGS-250, R422d
	6401-0511	MGS-250, R427a
	6401-0512	MGS-250, R507
	6401-0513	MGS-250, HFO1234YF
6401-0514	MGS-250, HFO1234ZE	
6490-9000	Installation and Operation Manual	

1.5. Specifications

Table 4: Technical Specifications

Specification	Description	
Power Supply	24 VDC, 24 VAC 50/60 Hz, 2.5 W max	
Power Monitoring	Green LED	
Visual Alarm	Red 4-digit LED display	
Audible Alarm	Buzzer (audible alarm), enable/disable	
Fault Monitoring	Fault codes presented to user	
Analog Outputs	4-20 mA; 0-5 V; 0-10 V; 1-5 V; 2-10 V	
Relay	1 relay rated 1 A @ 24 VAC/VDC (0.5A, 125V AC UL rating)	
Range	0-3500 ppm	
Squelch ¹	Readings below 75 ppm are squelched by default	
Communication: Modbus RTU over RS-485	Baud rate: 9,600 or 19,200 (selectable) Start bits: 1 Data bits: 8 Parity: None, odd, even (programmable) Stop bits: 1 or 2, programmable Retry time: 500 ms (min time between retries) End of msg: Silent 3.5 characters	
Alarm Delay	Selectable; 0 to 15 minutes	
IP Rating	Not IP rated. An accessory splash shield is available for areas requiring additional protection from wash down.	
Response Time, T90	< 5 minutes	
Temperature Rating	-22° to 104° F (-30° to 40° C)	
Humidity and Elevation	5-90% relative humidity, non-condensing, 0-10,000 ft. altitude	
Standard Dimensions and Weights	4.0" x 5.5" x 1.5"	6.3 oz
	102 x 140 x 37 mm	180 g
Approvals	CE, UL/CSA/IEC/EN 61010-1	

1 When filtering is disabled (see parameter P.-19 on page 42), the unit will respond to concentrations sub-10 ppm.

Section 2. Mounting the Gas Detector

2.1. Warnings and Prerequisites



WARNING: Explosion hazard! Do not mount the MGS-250 in an area that may contain flammable liquids, vapors, or aerosols. Operation of any electrical equipment in such an environment constitutes a safety hazard.



CAUTION: The MGS-250 contains sensitive electronic components that can be easily damaged. Do not touch or disturb any of these components.



NOTE: The mounting location of the monitor should allow it to be easily accessible for visual monitoring and servicing.



NOTE: The monitor must be connected to a marked, suitably located and easily reached switch or circuit-breaker as means of disconnection.



NOTE: Connect monitor power and signaling terminals using wiring that complies with local electrical codes or regulations for the intended application.



CAUTION: Do NOT mount the MGS-250 directly to vibrating machinery as the vibrations may degrade the gas detector's performance.

2.2. Mounting Locations

2.2.1. General Placement Guidelines



NOTE: The MGS-250 should be installed plumb and level and securely fastened to a rigid mounting surface.



NOTE: When installed in areas that may be subjected to water spray, the optional splash guard (P/N: 6900-0001) should be used in conjunction with the MGS-250.

Gas detectors must be located within the appropriate wire lengths from the central control unit (if used).

2.2.2. Machinery Rooms

There is no absolute rule in determining the number of gas detectors and their locations. However, a number of simple guidelines will help to make a decision. Gas detectors monitor a point as opposed to an area. If the gas leak does not reach the detector then no alarm will be triggered. Therefore, it is extremely important to carefully select the gas detector location. Also consider ease of access for maintenance.

The size and nature of the site will help to decide which method is the most appropriate to use. Locations requiring the most protection in a machinery or plant room would be around compressors, pressurized storage vessels, refrigerant cylinders or storage rooms or pipelines. The most common leak sources are valves, gauges, flanges, joints (brazed or mechanical), filling or draining connections, etc.

- In machinery rooms where there is **little or no airflow**, placement options are:
 - Point Detection, where gas detectors are located as near as possible to the most likely sources of leakage, such as the compressor, expansion valves, mechanical joints or cable duct trenches.
 - Perimeter Detection, where gas detectors completely surround the area or equipment.
- Halocarbon and hydrocarbon refrigerants are **heavier-than-air gases** and as such the gas detectors should be located near ground level (6 to 18 inches from the floor).

NOTE: Gas detectors should be positioned just far enough back from any high-pressure parts to allow gas clouds to form and be detected. Otherwise, a gas leak might pass by in a high-speed jet and not be detected by the gas detector.



- Make sure that pits, stairwells and trenches are monitored since they may fill with stagnant pockets of gas.
- For racks or chillers pre-fitted with refrigerant gas detectors, these should be mounted so as to monitor the compressors.
- Do not mount the gas detector directly to pipes or structures that are subject to strong vibration.

2.2.3. Refrigerated Spaces

In refrigerated spaces, gas detectors should be located away from doors, in the return airflow to the evaporators on a sidewall (below head-high is

preferred), or on the ceiling, not directly in front of an evaporator, nor in any direct airflow. In large rooms with multiple evaporators, gas detectors should be mounted on the central line between 2 adjacent evaporators, as turbulence will result in airflows mixing.

2.2.4. Chillers

In the case of small water- or air-cooled enclosed chiller units mount the gas detector so as to monitor airflow to the extract fans. With larger models also place a gas detector inside the enclosure under or adjacent to the compressors.

For enclosed air-cooled chillers or the outdoor unit for variable refrigerant volume and variable refrigerant flow (VRV/VRF) systems, mount the gas detector so as to monitor airflow to the extract fan. With large units also place a gas detector inside the enclosure under or adjacent to the compressors.

2.3. Mounting Procedure

To open the housing as received use a flat blade screwdriver and depress the top latch. While pushing the latch grasp the back edge of the housing near the latch and pull the back away.

When mounted, the housing is simply opened by pressing the top latch with a suitable screwdriver or other flat blade. With the top latch depressed pull the housing apart by grasping the sides and pulling straight out. With the housing separated the mounting base with terminal blocks will be visible. See Figure 5.



IMPORTANT: Do not apply caulking or other material around the gas detector base. The gas detector relies on air exchange through the spaces between the base and the gas detector housing. Do not obstruct the small gap around the housing and the base with any material.

Step	Mounting Procedure
1	Open the housing (see Figure 5).
2	Position the base to the pre-determined (acceptable) mounting location. Use the gas detector base to mark the mounting locations as needed. The hole pattern on the back plate is sized to mount the gas detector onto various electrical junction boxes. The other holes may be used as needed to mount the gas detector to other structures, or onto a wall.

Step	Mounting Procedure	
3	<p>Wall Mount</p> <p>Attach the MGS-250 base to the mounting surface using two #6 screws (provided) through two of the 7 mounting holes, being careful not to over-tighten the screws. Refer to Figure 6 for the locations of mounting holes on the base.</p>	<p>Junction Box Mount</p> <p>Attach the MGS-250 base to the junction box (using mounting hardware provided with your junction box) through the two junction box holes. Refer to Figure 6 for the locations of the two junction box mounting holes on the base.</p>
4	<p>Unless you are ready to wire the device (see section 3), carefully snap the cover onto the base unit.</p>	

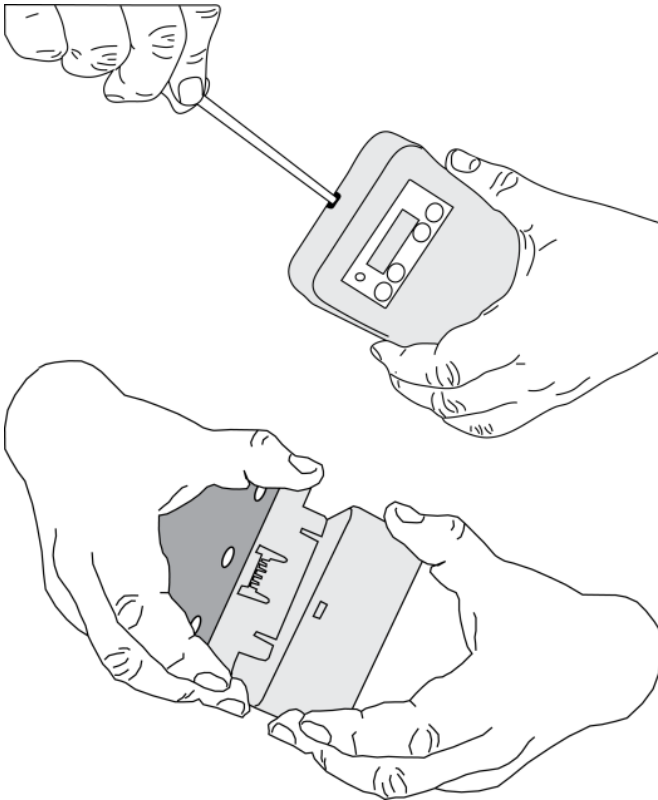
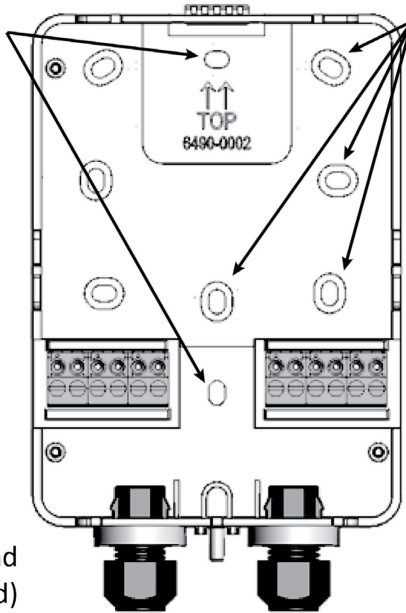

Figure 5. Initial Housing Separation

Junction Box
Mounting
Holes
(2 Places)



Flat Surface
Mounting
Holes
(7 Places)

NOTE: Use #6
screw or smaller
for wall mounting.

Cable Gland
(Installed)

Cable Gland
(Optional)
or Blanking Plug
(Not Shown)

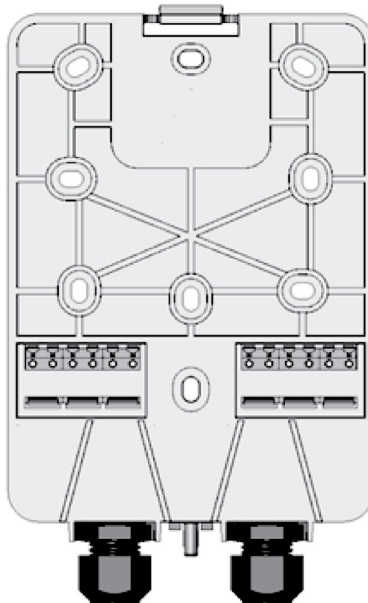

DO NOT apply
caulking or
sealant on or
around the
MGS-250 or its
base.

Figure 6. Front and Back Views of MGS-250 Base

Section 3. Wiring and Configuration

3.1. Overview

Prior to wiring and configuring the MGS-250, assure the following conditions have been met:

- MGS-250 backplate is mounted in an appropriate location
- the cover panel is removed.

If the cover panel was reattached after mounting, open the gas detector enclosure by pressing the top latch with a suitable screwdriver or other flat blade. With the top latch depressed pull the housing apart by grasping the sides and pulling straight out. Align and press together to close.

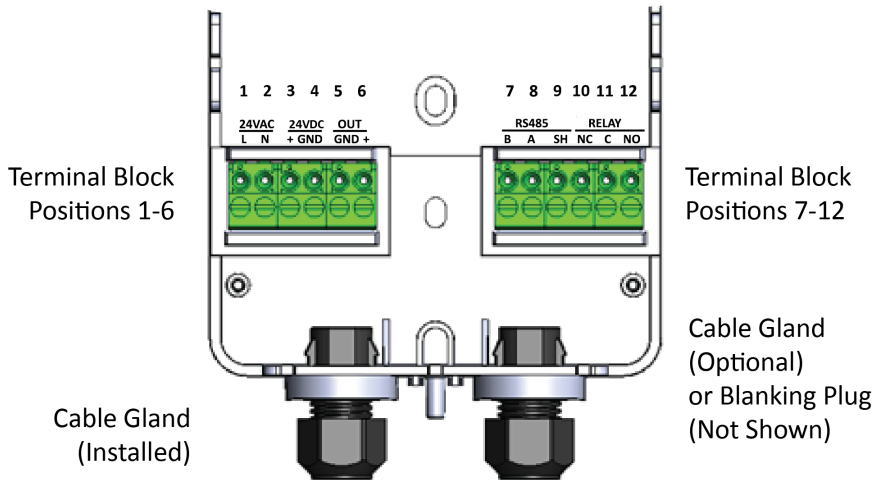

Figure 7. Terminal Blocks and Cable Glands



NOTE: The pre-installed cable gland (left) and optional cable gland (right) have a 1/4" cable capacity (each).



NOTE: Install the optional cable gland on the right side of the base unit if needed. Otherwise, install the blanking plug that is included in the mounting kit.

3.2. Wiring Supply Power (24VAC or 24VDC)



WARNING: Incorrect wiring may permanently damage the gas detector, and void the warranty. Double check all terminations before applying power.

Either 24VAC or 24VDC may be used to power the MGS-250. Connect wiring to the appropriate terminal locations (see Table 5). Use 2 wires, between 14 and 22 AWG. Refer to Figure 8 for (AC wiring left) or DC wiring (right).

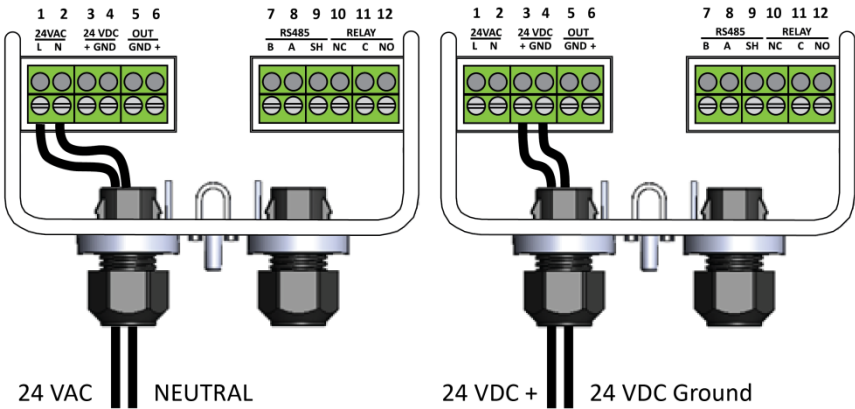

Figure 8. Supply Power Wiring Options

Table 5: Power Options and Terminal Block Connections

Power Option	Pin	Label	Wiring Termination
24 VAC	1	L	24V AC line
	2	N	24V AC neutral
24 VDC	3	+	24V DC positive
	4	GND	24V DC ground

WARNING: The MGS-250 must be powered by either:



- a suitable UL 60950/CSA certified power supply that is isolated from line voltage by double insulation, or
- an appropriately rated UL listed/CSA Class 2 transformer.

Failure to comply can result in personal injury or death.



WARNING: Neutral polarity must be maintained across units. Refer to Figure 9.

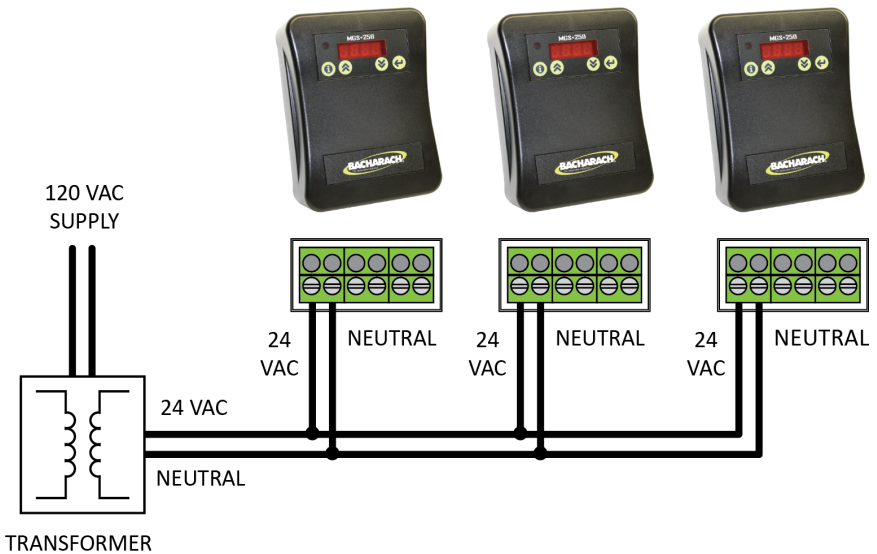

Figure 9. Maintaining Neutral Polarity

3.3. Wiring Alarm Output (Analog Signal)

The MGS-250 provides an analog output signal that is proportional to the level of gas detected.



NOTE: No jumpers or hardware switch settings are required to configure the analog output. This is done electronically from the front panel display.

Connect two 18 to 20 AWG wires to terminal block positions 5 and 6 (see Figure 10), noting ground and signal polarity per Table 6.

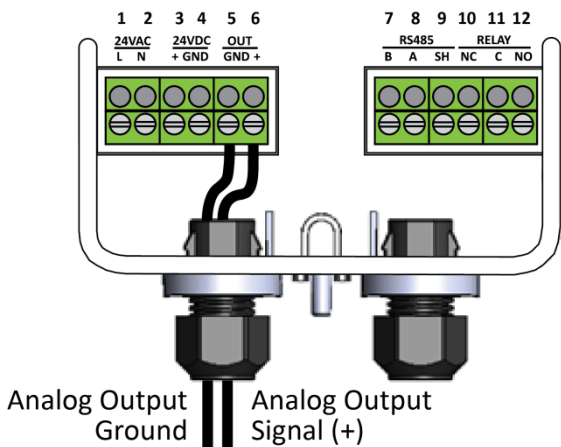

Figure 10. Analog Output Wiring

Table 6: Alarm Output Terminal Block Connections

Function	Pin	Wiring Termination
Analog Output	5	Analog output ground
	6	Analog output signal (+)

The type of output signal on pins 5 and 6 is programmable using the analog output type parameter P.-03. Refer to Section 5 for details.

3.4. Wiring the Digital Alarm Output Relay

An alarm setpoint may be programmed from the front panel of the MGS-250. When the sensed gas level exceeds the alarm setpoint, the MGS-250 enters the alarm state. An on-board relay is tied to the alarm state, so you may activate (or deactivate) external equipment based on the MGS-250's current alarm status.

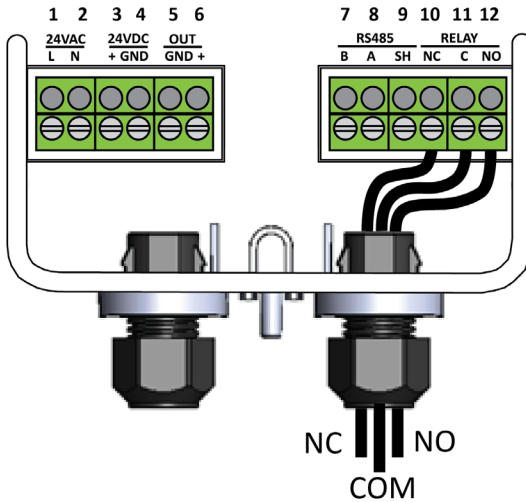

Figure 11. Sample Relay Output Wiring



NOTE: The relay can be programmed to be failsafe (normally energized). By default, the relay is set to be normally de-energized. This can be set using parameter P-06.

Make relay connections (NO, NC, or both) using 18 to 20 AWG wires to terminal block positions 10, 11, and 12 (see Figure 11), noting normally open, normally closed, and common connectors per Table 7.

Table 7: Relay Output Terminal Block Connections

Function	Pin	Wiring Termination
Relay (Alarm) Output	10	Relay NC contact
	11	Relay common contact
	12	Relay NO contact

3.5. Modbus Network Configuration

If your application includes a Modbus network, make network connections (RS-485 A and RS-485 B) using 18 to 24 AWG shielded twisted pair wires (with 120 ohm characteristic impedance) to terminal block positions 7 and 8 (see Figure 12), noting inverted B (-) and non-inverted A (+) signal connectors per Table 8.

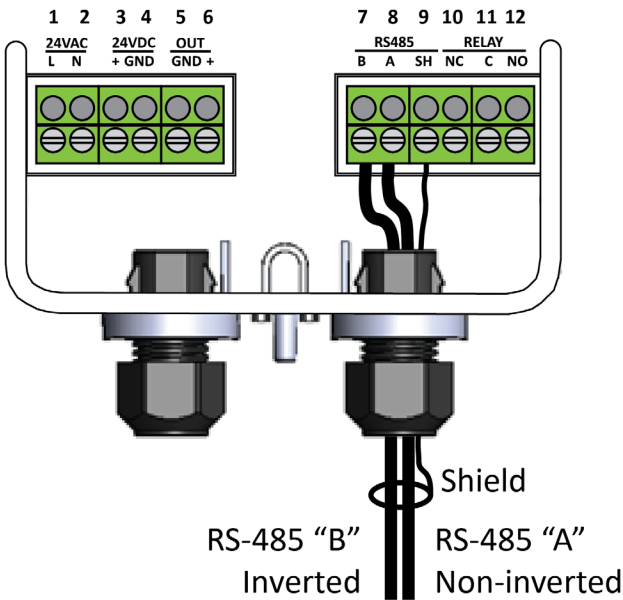

Figure 12. Modbus Network Wiring

Table 8: Modbus Network Communications Connections

Function	Pin	Wiring Termination
Modbus Network Communications	7	RS-485 “B” (inverted)
	8	RS-485 “A” (non-inverted)
	9	RS-485 shield



IMPORTANT: For Modbus network communications wiring, use only 18-24 AWG shielded twisted pair wire with 120 ohm characteristic impedance.



IMPORTANT: Connect the RS-485 cable shield to pin 9 (board ground).



NOTE: Selection of the Modbus Address and Baud Rate is completed through the gas detector setup menu, described later. No jumpers or hardware switch settings are required to configure the Modbus communications network. This is done electronically from the front panel display.



NOTE: For Modbus communications with the MGS-250, the default communications parameters are as follows.

- Baud rate = 9,600
- Parity = no parity
- Stop bits = 1

Confirm that all devices on the Modbus communications network (including a Building Management System) are configured similarly.

If the MGS-250 is at the end of the RS-485 network, then be sure to set the RS-485 terminator on the printed circuit board (PCB) to IN. This applies a terminating resistor to the end of the wires per the requirements of the RS-485 protocol. The terminator should be set to OUT for all other installation conditions.



IMPORTANT: Be sure to enable the termination resistor on the device at each end of the network (see Figure 13). This includes the Building Management System (if used).



NOTE: Care should be exercised when changing the terminator switch. Before powering the gas detector, use a fine pointed device or paper clip to slide the switch position. Do not apply force to the switch or push on the switch with any device. The switch changes position up and down along the access slot direction.

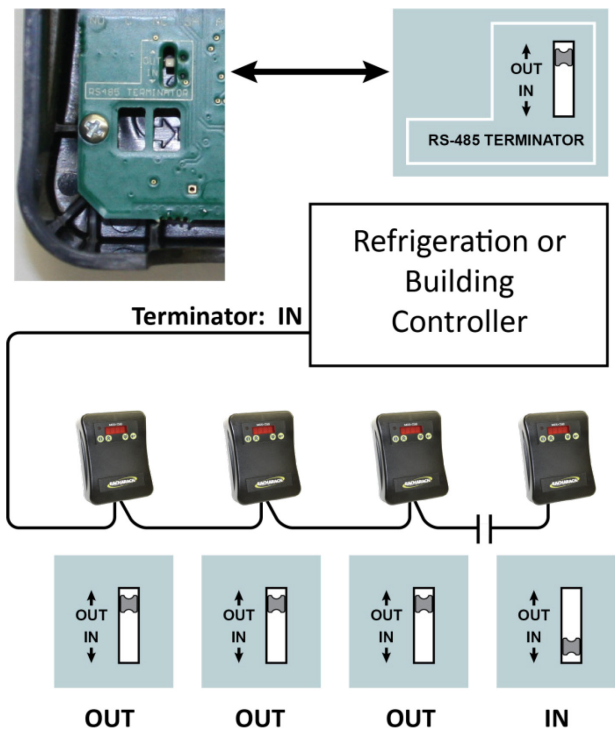

Figure 13. Setting Network Termination Resistors

3.6. Conclusion

Once the base is mounted and all wiring is complete, align the gas detector housing and press it onto the base. The gas detector will snap into position, completing all electrical connections. Ensure the top and bottom snap locks are engaged.



IMPORTANT: If the right cable gland was not needed during installation and wiring, be sure to install the blanking plug.



IMPORTANT: Do not apply caulking or other material around the gas detector base. The gas detector relies on air exchange through the spaces between the base and the gas detector housing. Do not obstruct the small gap around the housing and the base with any material.

Section 4. Operation and Stabilization

4.1. Power Up and Warmup

On powering up, the MGS-250 will sense for the presence of gas after an initial warm-up period of 2 to 5 minutes. The green LED will flash at a 1 second interval during the warm up.

4.2. Stabilization



IMPORTANT: It is vital when first installing the gas detector that it warms up in an atmosphere that is known not to contain any background concentrations of refrigerant. Bacharach offers portable gas detectors for this purpose. Contact the factory for more information.

4.3. Perform a Manual Zero

After the gas detector stabilizes, the power LED stops flashing and is lit continuously. Bacharach recommends manually zeroing the MGS-250 after a 1-hour stabilization period.

To manually zero the gas detector, press and hold the UP and DOWN buttons simultaneously for 5 seconds. The gas detector will beep and the display will show “zEro” when zeroing is complete. The display will show fAiL if the temperature is changing too quickly or there is an active alarm condition.



NOTE: Manual zero should be performed in the environment of operation and at the typical operating temperature.



NOTE: Subsequent manual zeroes *may be performed*, provided the atmosphere around the gas detector is free of all background concentrations of refrigerant. Clean air or nitrogen applied to the calibration port for five minutes may be used to ensure the gas detector is clear of all background gas. Re-zeroing with background refrigerant present will cause the gas detector to report incorrect readings.

4.4. Alarms

The following occurs during an alarm condition.

Table 9: MGS-250 Behavior during Alarm Conditions

Item	Behavior During Alarm State
Green LED	On (solid)
Display	On (blinks); reports detected PPM concentration
Audible Alarm	On (if enabled and after programmed delay expires)
Relay Output	Activates (after any programmed delay expires)
Analog Output	Changes proportionally with gas concentration (as configured)
Modbus Registers	Registers indicate the alarm condition, ppm concentration, etc.



NOTE: The alarm feature includes a 20% dead band to prevent alarm ‘chatter’ if the concentration hovers near the alarm setpoint. Once the alarm has been triggered it will remain latched until the concentration drops below 80% of the alarm setpoint.

4.5. Gas Detector Faults

4.5.1. Overview

There are two levels of fault monitoring built into the gas detector.

- Non-critical
- Critical

4.5.2. Non-Critical Faults

Non-critical faults typically recover by allowing the gas detector surroundings to stabilize, for example, after a defrost cycle. The gas detector continues to monitor its surroundings during non-critical faults, but may report inaccurate readings.

The following occurs when a non-critical fault condition exists.

Table 10: MGS-250 Behavior during a Non-Critical Fault

Item	Behavior During Non-Critical Fault State
Green LED	On (solid)
Display	Shows the appropriate fault code
Analog Output	Operates normally
Modbus Registers	Modbus registers indicate the fault.

4.5.3. Critical Faults

Critical faults may indicate an unrecoverable condition. Please refer to Section 8 for more information. The following occurs when a critical fault condition exists.

Table 11: MGS-250 Behavior during a Critical Fault

Item	Behavior During Critical Fault State
Green LED	Off (indicating the gas detector is off-line)
Display	Shows the appropriate fault code
Analog Output	4-20 mA output Changes to 2 mA
	1-5 V output Changes to 0.5 V
	2-10 V output Changes to 1.0 V
Modbus Registers	Modbus registers indicate the fault.

Section 5. Configure the Gas Detector

5.1. User Interface Overview

The gas detector is configured through the built in menu system. Once mounting is complete, attach the gas detector to the base and apply power.

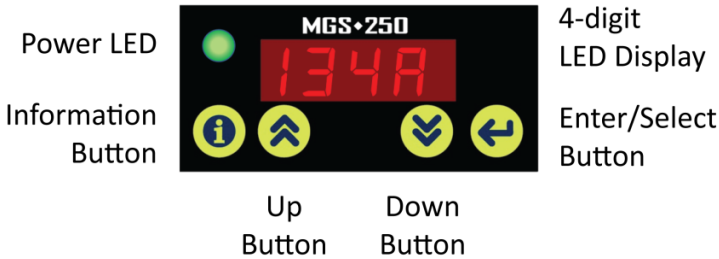



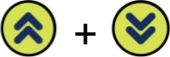



Figure 14. The User Interface of the MGS-250

The user interface consists of four pushbuttons, a four digit LED numeric display, and a power LED. When the display is off, press any button to wake the display for 10 seconds. Buttons functions are listed in Table 12.

Table 12: Button Functions

Button	Description
	Used to access the parameter list. Used to back up one level without writing to memory when the parameter list is active. Used to mute the audible alarm for the time period configured in parameter P.-12.
	Used to increment the value or parameter displayed.
	Used to decrement the value or parameter displayed.
	When pressed together and held for 5 seconds, this key combination manually zeroes the gas detector.
	Saves the currently displayed parameter to memory.

5.2. Setting Parameters

5.2.1. Overview



Press and hold the information button (ⓘ) for 5 seconds to activate the parameter list. Each parameter is shown in turn by using the UP or DOWN buttons. The parameter is shown as P.-XX, with XX being the parameter value. Pressing Enter while a parameter is displayed allows the attributes of the parameter to be set. Each Parameter has its own attributes, as shown in the following table. Set the attributes as desired, and then press Enter to save the setting.

5.2.2. Configuration Parameters

Table 13: Parameter Numbers, Names and Descriptions

Parameter	Description
P.-01	<p>Maintenance Mode Sets gas detector to offline mode for 30 minutes.</p> <p>00 Gas detector is online, with normal response to its surroundings (default).</p> <p>01 Gas detector is offline, and suppresses all outputs. Display reads “oFFL” (offline) during 30 minute timeout.</p>
P.-02	<p>Alarm Setpoint Sets desired PPM value (range 75 to 3500 ppm) above which alarm occurs. Use UP or DOWN buttons. For faster “coarse” adjustment, hold either button to sweep through the adjustment range quickly. Default setpoint is 100 ppm.</p>
P.-03	<p>Analog Output Type Selects output type.</p> <p>00 Selects 0-5 V (default)</p> <p>01 Selects 1-5 V</p> <p>02 Selects 0-10 V</p> <p>03 Selects 2-10 V</p> <p>04 Selects 4-20 mA</p>

Parameter	Description
P-04	<p>Alarm ON Delays</p> <p>Sets the ON delay time (0-15 minutes) for the alarm output signals (relay, Modbus). The default delay is 0 minutes.</p>
P-05	<p>Alarm OFF Delays</p> <p>Sets the OFF delay time for the alarm output signals (relay, Modbus) in minutes (0-15). The default delay is 0 minutes.</p>
P-06	<p>Relay Contact Behavior (Failsafe Mode)</p> <p>Sets the default relay power state so that power loss can be detected.</p> <p>The behavior of the relay changes from energizing when an alarm condition occurs (default) to energizing at power up (Failsafe). In both cases the relay changes state when an alarm occurs, failsafe is simply inverted. This allows power failures to be detected as alarms.</p> <p>00 NO (default mode) 01 Failsafe mode</p>
P-07	<p>Relay Latching</p> <p>Controls the relay latching behavior.</p> <p>00 OFF (default). Relay does not latch, and resets once the alarm condition is removed. 01 ON. Relay remains latched; reset by BMS command over RS-485, or by pressing and holding the Enter button for 5 seconds.</p>
P-08	<p>Audible Alarm</p> <p>The units have an internal audible alarm. You can disable this, but the default setting is “enabled” in compliance with EN378.</p> <p>00 OFF 01 ON (default)</p>

Parameter	Description
	<p>Display Mode</p> <p>The display can be turned on by using this parameter. When set to ON the display never shuts off (all operating modes). When ON the display shows the current gas concentration (or 0 if below the squelch). Note that P.-09 is disabled if P.-19=0.</p> <p>00 OFF during normal operation when the ppm value is below the alarm setpoint (default)</p> <p>01 ON</p> <p>In either case, the display will blink the measured PPM value during an alarm state.</p>
	<p>RS485 Node Address</p> <p>Sets the RS-485 node address (0001 to 0255).</p>
	<p>Gas Groups / Specific Gas Selection</p> <p>Selects either gas group number for broadband operation or specific gas name for gas-specific mode.</p> <p><u>Broadband</u>: Select from 3 groups of gases:</p> <ul style="list-style-type: none"> 1 R134a, R404a, R407a, R407c, R407f, R427a, R507, 2 R422a, R422d HFO1234YF, and HFO1234Ze 3 R22 (by itself). <p><u>Specific Gas</u>: The actual refrigerant name is shown. Select the appropriate refrigerant.</p> <p>NOTE: Gas-specific detectors are factory calibrated to a single refrigerant using specialized manufacturing equipment. If another refrigerant is selected which differs from the factory calibrated setting, the built in calibration no longer applies. Further improvement in detector accuracy may be gained by applying calibration gas containing the newly selected refrigerant and adjusting the gas detector reading to match (see Parameter P.-17).</p>

Parameter	Description
P-012	<p>Buzzer Mute Time</p> <p>Sets a time (0-59 minutes) during which the active buzzer remains muted:</p> <ul style="list-style-type: none"> • after the “I” button is pressed, or • after Modbus register 4000 is set to 0.
P-013	<p>Baud Rate</p> <p>Sets the baud rate for Modbus (RS-485) communications.</p> <p>00 9,600 baud (default)</p> <p>01 19,200 baud</p>
P-014	<p>Stop Bits</p> <p>Sets the number of stop bits required to match the controlling communications equipment (e.g., building management system, etc.).</p> <p>01 1 stop bit (default)</p> <p>02 2 stop bits</p>
P-015	<p>Parity</p> <p>Sets Modbus parity option.</p> <p>00 None (default)</p> <p>01 Odd parity</p> <p>02 Even parity</p>

Parameter	Description
	<p>Analog Output Scaling</p> <p>Allows the user to select the full-scale PPM value that represents maximum analog output (e.g., 20 mA) for scaling the analog output. Adjustment range is from 100 PPM to 3500 PPM. Default = 3500 PPM. (The setting cannot be adjusted above 3500.)</p> <p>Use the Up and DOWN buttons to set the desired full scale value. All outputs will be scaled to the indicated full scale value.</p> <p>NOTE: Alarm values are not scaled, but are absolute values. Setting a smaller full scale does not correspondingly scale the alarm setting.</p> <p>NOTE: When the ppm level is greater than the programmed analog output Full Scale ppm (P.-16), the analog output will go to a 10% over range state (indicating that the concentration is too high for the analog output to achieve). For example, for a 1-5 V setting the analog output would go to 5.5 V, for 4-20 mA it would go to 22 mA and so on.</p>



NOTE: The analog output signal range is from 100 ppm to the default value of 3500 ppm, which is scaled across the actual output range selected by the analog output type parameter P.-03. The upper PPM limit is programmable using analog output scaling parameter P.-16. This parameter sets the full scale PPM value creating a PPM range across which the analog output is scaled. See Figure 15 for more details.

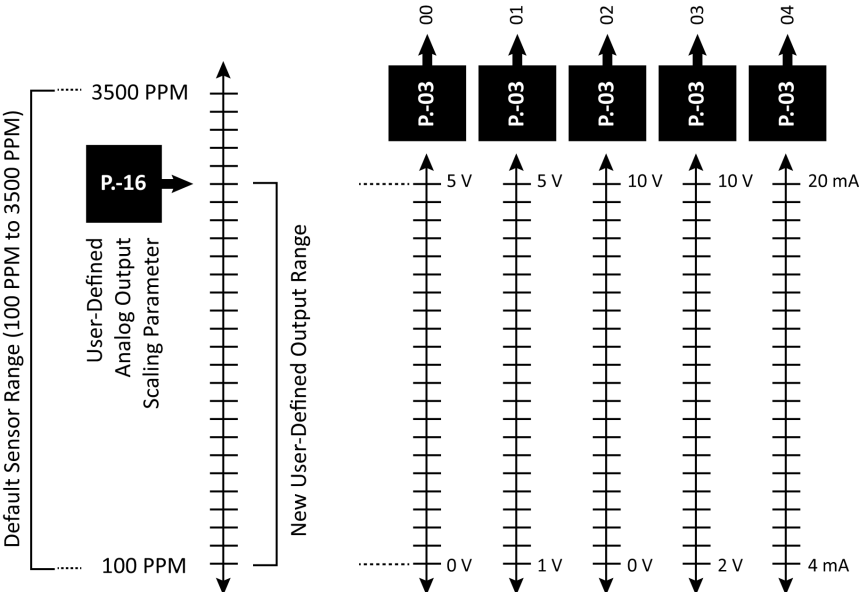





Figure 15. Analog Output Scaling Options

Parameter	Description
	<p>Gas Test Mode</p> <p>Places the gas detector in gas test mode.</p> <p>00 Disabled (default)</p> <p>01 Enabled</p> <p>When enabled, the display continuously cycles through the following:</p> <ul style="list-style-type: none"> • CAL is displayed briefly. • Next, the gas group number or gas type (based on product code) is displayed. • Then four dashes (----) are displayed. <p>After gas is applied and the 75 PPM squelch level is exceeded, the live concentration replaces the four dashes.</p> <p>See section 6.4 if using Gas Test Mode to initiate the calibration procedure.</p> <p>NOTE: To prevent false alarms, all outputs are suspended while Test Mode is active. The only live indication is the 4-digit display.</p> <p>Once the gas test mode is enabled to perform a gas test or calibration, the unit will automatically go offline for a ten minute period after the parameter list is exited. (This allows time for the test gas to clear before the unit becomes active)</p> <p>If no activity occurs for ten minutes, the unit exits the gas test mode.</p>

Parameter	Description
	<p>Diagnostics Menu</p> <p>Parameter 18 provides access to the self diagnostic information. The LED display shows “DIAG” until the Enter button is pressed. Use the UP and DOWN buttons to scroll through the list of diagnostic attributes.</p> <p>A.-01 Current fault condition A.-02 Last fault A.-03 Days in service A.-04 Days since last adjust/test A.-05-A.-07 <i>Factory Use Only</i> A.-08 Detector temperature in °C A.-09 Temperature rate of change A.-10-A.-17 <i>Factory Use Only</i></p> <p>To aid in troubleshooting, the operator may choose to reset the gas detector to its default state by holding both the UP and DOWN buttons for 5 seconds while in the Diagnostics Menu. All settings, including the alarm setpoint, gas adjustments, the selected gas curve, calibration data, the Modbus address, etc. revert to specific default values after a reset.</p> <p>IMPORTANT: Calibrations on either gas-specific or broadband models are lost after a reset. This returns the gas detector to an uncalibrated condition. See parameter P.-17 for information on how to recalibrate the gas detector.</p> <p>See Section 8 for a complete list of codes and details on the reset option.</p>

Parameter	Description
	<p>Response Filtering</p> <p>This parameter is used to turn filtered output ON (01) or OFF (00).</p> <p>The default setting is ON (01). The Modbus and analog output are filtered so that responses below 75 ppm are squelched. If the display mode (P.-09) is set to ON (01) the display shows 0 for any signal level below 75 ppm.</p> <p>Some installations may wish to monitor the small analog output changes that may be created by the detector environment. Turning filtering OFF (00) allows these small variations around the minimum analog output (e.g., 4 mA, 1V, etc.) to be transmitted via Modbus and the analog output terminals.</p> <p>NOTE: The detector display is OFF when filtering is OFF (P.-09 is disabled).</p> <p>NOTE: Whenever filtering is OFF the detector display will turn ON for 10 minutes if the detector is re-zeroed (see Section 4.3). This is intended to aid maintenance testing. The analog outputs continue to transmit the full, unfiltered range, and the alarm setpoint remains active.</p>

5.3. Completing Setup

To complete the setup after all parameters are set as needed, simply press and hold the information button (ⓘ) for 5 seconds to exit the Parameter list. The gas detector is now actively monitoring its surroundings.



NOTE: If no buttons are pressed for 2 minutes, the MGS-250 exits setup mode automatically.

Section 6. Functional Tests and Adjustments

6.1. Introduction

To comply with the requirements of EN378 and the European F-GAS regulation, gas detectors must be tested annually. However, local regulations may specify the nature and frequency of this test.



CAUTION: Check local regulations on calibration or testing requirements.



CAUTION: The MGS-250 contains sensitive electronic components that can be easily damaged. Neither touch nor disturb any of these components



IMPORTANT: Bacharach recommends annual checks and adjustment using calibration gas. Calibration gas adjustment frequency may be extended based on application, but should never exceed 2 years.



CAUTION: In applications where life safety is critical, calibration gas adjustment should be done quarterly (every 3 months) or on a more frequent basis. Bacharach is not responsible for setting safety practices and policies. Safe work procedures including calibration policies are best determined by company policy, industry standards, and local codes.



CAUTION: Failure to test or adjust the unit in accordance with applicable instructions and with industry guidelines may result in serious injury or death. The manufacturer is not liable for any loss, injury, or damage arising from improper testing, incorrect adjustment, or inappropriate use of the unit.



IMPORTANT: Before testing the gas detectors on-site, the MGS-250 must have been powered up and allowed to stabilize.



IMPORTANT: After initial installation, the MGS-250 should be gas tested to ensure proper operation.

IMPORTANT: The testing and/or adjustment of the unit must be carried out by a suitably qualified technician, and must be done:

- in accordance with this manual
- in compliance with locally applicable guidelines and regulations.



Qualified operators of the unit should be aware of the regulations and standards set down by the industry/country for the testing or calibration of this unit. This manual is only intended as a guide and, insofar as permitted by law, the manufacturer accepts no responsibility for the calibration, testing, or operation of this unit.

The frequency and nature of testing or calibration may be determined by local regulation or standards.

EN378 and the F-GAS Regulation require an annual check in accordance with the manufacturer's recommendation.

6.2. Bump Testing vs. Adjusting Detector Response

There are two concepts that need to be differentiated.

- bump test
- gas detector response adjustment

A *bump test* exposes the gas detector to a gas. The operator then observes the gas detector's response to the gas. The objectives are two-fold:

- establishes if the gas detector is reacting to the gas
- determines if all of the detector outputs are working correctly

There are two types of bump test.

- quantified: A known concentration of gas is used.
- non-quantified: A gas of unknown concentration is used.

Adjusting gas detector response exposes the gas detector to a calibration gas as well (like a quantified bump test), but additionally sets

the actual gas detector response level (via parameter P.-17) to ensure that the gas detector activates at the specified gas concentration.

Refer to the following sections for addition information on bump testing and gas detector response adjustment.

CAUTION: Before you carry out the test or adjustment:



- Advise occupants, plant operators, and supervisors.
 - Check if the gas detector is connected to external systems such as sprinkler systems, plant shut down, external sirens and beacons, ventilation, etc. and disconnect as instructed by the customer.
 - For bump test or calibration the MGS-250 should be powered up and fully stabilized per Section 4.
-

6.3. Bump Testing



IMPORTANT: Notify others that testing is underway. During bump testing the alarm outputs are active, and will trigger whatever response is intended. It is the operator's responsibility to ensure that such actions are acceptable and can be performed safely.

After installation and parameter setup (see Section 5), the units should be bump tested. Expose the gas detector to test gas. The gas selected should be a high enough concentration to put the system into alarm and light the LED display.

With a bump test you can see the functions of the gas detector:

- the LED display will light and show the detected PPM concentration once the alarm setpoint is reached
- the relay and audible alarm will function **as configured** including any delays set (ON or OFF).
- the output (0-10V, for example) will show the gas level

Ideally bump tests are conducted on-site in a clean air atmosphere.

Step	Bump Testing Using Calibration Gas Cylinders
1	Remove the Splash Shield accessory if one is used.
2	Connect the regulator to the test gas port using 3 mm or 1/8" inside diameter tubing (see below).
3	Expose the gas detector to gas from the cylinder. Monitor the LED display reading. Refer to the specifications section for acceptance criteria.



Figure 16. Using Calibration Gas

6.4. Adjustment Using Calibration Gas

Adjustment Using Calibration Gas requires a gas cylinder with the appropriate gas and concentration. Note that Bacharach offers a calibration kit that consists of a calibration gas cylinder and a flow regulation valve with flexible non-absorbent tubing.



NOTE: For improved accuracy and response, the gas detector should be protected from excess drafts while performing the adjustment. Excess air circulation may dilute the applied calibration gas and lead to lower than expected response.

Step	Adjustment Using Calibration Gas Cylinders
1	Connect the regulator to the test gas port using 3 mm or 1/8" inside diameter tubing.
2	<p>Enable parameter P.-17 Gas Test Mode (see Section 5). When enabled, the display continuously cycles through the following:</p> <ul style="list-style-type: none"> • CAL is displayed briefly. • Next, the gas group number or gas type (based on product code) is displayed. • Then four dashes (----) are displayed. <p>After gas is applied and the 75 PPM squelch level is exceeded, the live concentration replaces the four dashes.</p> <p>NOTE: The analog outputs, relay activity, and RS-485 ppm reporting are suspended in Gas Test Mode to prevent false alarms.</p>
3	Expose the gas detector to gas from the cylinder. Monitor the 4 digit LED display reading.
4	Wait for the ppm reading to stabilize. This should take approximately 4-6 minutes. Minor changes (less than 5 ppm in 10 seconds) are considered stable readings. Compare the response value with the calibration gas concentration.
5	Adjust the gas detector displayed value by using the UP or DOWN buttons to increase or decrease the value shown. Adjust until the reading is within $\pm 2\%$ of the calibration gas. For example, if the calibration gas is 1000 ppm, the gas detector is adjusted properly when the displayed reading is between 980 and 1020 ppm.
6	Press the Enter button to store the new adjustment. Turn off the calibration gas and remove the tubing from the calibration port.

Step	Adjustment Using Calibration Gas Cylinders
7	If no further changes to the other parameters are required, press and hold the Ⓢ button for 5 seconds to exit the Parameter list. Upon exiting the parameters list, the gas detector will enter offline mode for a period of 10 minutes. This allows time for the calibration gas to dissipate after testing. During offline mode, the gas detector suppresses all outputs. The display reads “oFFL” (offline) during 10 minute timeout.



NOTE: All calibration gas mixtures have a blend tolerance. The tolerance will limit the actual adjustment accuracy that is achievable.

Section 7. Modbus Communications

7.1. Introduction

The MGS-250 gas detector can be configured to communicate on an RS-485 network using Modbus-RTU protocol. Before configuring the gas detector for Modbus communications, be sure your network connection is complete and your network termination switches are set appropriately. Refer to Chapter 3 (Wiring and Configuration) for details.

This section details the MGS-250 parameters that can be accessed via registers of the Modbus-RTU (“Modbus”) protocol. Generally (with the exception of some of the communications parameters), parameters you can access and/or configure from the front panel of the MGS-250 can also be accessed and/or configured via a Building Management System (for example) on the same Modbus network.

7.2. Communications Settings

There are 255 selections available to be set electronically, from addresses 1 to 255 inclusive. Modbus data with a zero in the address field is received by all detectors (regardless of the address selected) to enable the master device to broadcast simultaneously to all the detectors.

Refer to the specifications section (page 16) for information on RS-485 network communications parameters such as data bits, stop bits, etc.

7.3. Analog Input Registers

Analog input registers are read only and use function code 04.

Table 14: Analog Input Registers

Reg	Description	Range	Units	P.##
1000	Concentration gas level	0-100	% FS	--
1001	Concentration gas level	0-65,535	ppm	--
1002	<i>Reserved</i>			--
1003	Full scale detector level	0-65,535	ppm	--
1004	Alarm set-point (% full scale)	0-100	%	--
1005	Gas detector timer	0-65,535	hours	--
1006	Node address	1-247	none	P.-10
1007	Software version		none	--
1008	<i>Reserved</i>			--
1009	<i>Reserved</i>			--
1010	<i>Reserved</i>			--
1011	<i>Reserved</i>			--
1012	16-bit fault code	0-65535	none	--

7.4. Analog Output Registers

Analog output registers are readable (using function code 03) and writable (using function code 06).

Table 15: Analog Output Registers

Reg	Description	Range	Units	P.-##
2000	Alarm setpoint	75-3500	ppm	P.-02
2001	Alarm ON delay (Alarm flag register 3000 is set to 1)	0-15	min	P.-04
2002	Buzzer mute time	0-59	min	P.-12
2003	Alarm OFF delay	0-15	min	P.-05
2004	Relay action	0=NO 1=Fail-safe	none	P.-06
2005	Relay latching enable	0=Disable 1=Enable	none	P.-07
2006	Buzzer enable	0=Disable 1=Enable	none	P.-08
2007	Display mode	0=Off 1=On	none	P.-09
2008	Analog output type	0=0-5 V 1=1-5 V 2=0-10 V 3=2-10 V 4=4-20 ma	none	P.-03
2009	Baud rate	0=9600 1=19200	none	P.-13
2010	Stop bits	1 or 2	none	P.-14
2011	Gas curve number	1 to 3 (broadband unit) or gas type (gas specific)	none	P.-11
2012	Analog output full scale ppm (R/O)	100 – 3500	ppm	P.-16
2013	Parity	0=None 1=Odd 2=Even	none	P.-15

7.5. Input Status Flags

Input Status Flags are readable (using function code 02).

Table 16: Input Status Flags

Reg	Description	Range	P.##
3000	Alarm flag (0 or 1=Alarm)	0-1	--
3001	Relay state (0 or 1=energized)	0-1	--
3002	Detector fault (0 or 1=fault)	0-1	--
3003	Red LED state (0 or 1=ON)	0-1	--
3004	Green LED state (0 or 1=powered on)	0-1	--
3005	<i>Reserved</i>		--
3006	Start up (0=normal operation 1=warming up)	0-1	--
3007	<i>Reserved</i>		--
3008	<i>Reserved</i>		--

7.6. Output Status Flags

Output Status Flags are readable (using function code 01) and writable (using function code 05).

Table 17: Output Status Flags

Reg	Description	Range	P.##
4000	Buzzer flag (0 or 1=ON)	0=Off 1=On	--
4001	Test required (If operating for >1 year). (1=requires testing)	0=Okay 1=Test	--

Section 8. Troubleshooting

8.1. Fault Codes

To comply with the requirements of EN378 and the European F-GAS regulation, gas detectors must be tested annually. However, local regulations may specify the nature and frequency of this test.

The MGS-250 features sophisticated internal status monitoring and will indicate whether a fault condition exists, both on the front display (F.-XX, with XX being the fault number) and over the Modbus communications network.

There are two classes of fault conditions: critical and non-critical. In general, non-critical faults occur...

...when environmental conditions exist that are outside the product's specified operating range, or if an installation error has occurred (wrong wiring, for example).

The gas detector will typically continue to monitor its surroundings (except for fault F.-08), and may report inaccurate readings and false alarms.

Correcting non-critical faults is a matter of waiting for the environmental conditions to return to a more typical condition, correcting wiring mistakes, or in some cases, relocating the gas detector. For example, placing the gas detector near a forced air heater may cause temperature faults. The non-critical fault range is F.-01 to F.-08. Critical faults indicate...

...a functional problem that results in the gas detector no longer monitoring its surroundings for refrigerant.

The fault number is displayed and the power LED is turned off, indicating that the gas detector is offline. The critical fault range is F.-09 to F.-16. If any of these faults occur, first try to clear the faults by cycling power to the sensor. The easiest way to do this is by removing the sensor from the base and reattaching. If the fault returns after cycling power, the gas detector should be removed from service and replaced.

Additionally, the faults are stored as a hex number and can be accessed in the Diagnostics menu P.-18. The associated hex codes are listed next to the Fault Code in Table 18. Refer to Diagnostics Menu P.-18 in the next section for additional information.

Table 18: Fault Codes

Description	Fault Code	Hex Code	Possible Causes
Gas Detector Temperature Fault	F.01	0x0001	Gas Detector temperature reports > 55° C or < -35° C.
Gas Detector Temperature Rate of Change Fault	F.02	0x0002	Temperature rate of change exceeds ~1°C/min for more than 15 minutes.
RS485 RX Fault	F.03	0x0004	Message too long for receive buffer.
RS485 CRC Fault	F.04	0x0008	Transmission is corrupted (computed CRC doesn't match transmitted CRC).
Open Loop Fault	F.05	0x0010	Possible wiring, connection, and/or termination issue exists. When analog output type is 4-20ma and loop is open, use 18-24AWG shielded twisted pair with 120 ohm characteristic impedance for Modbus connections.
Modbus Fault	F.06	0x0020	Modbus message was truncated or timed out early.
PPM Over-range Fault	F.07	0x0040	PPM exceeds 9999. This may indicate a very large gross leak. If no leak is present, it indicates a gas detector error.
Input Voltage Fault	F.08	0x0080	Input supply power to the MGS-250 is out of range (i.e., 24V ±20%). IMPORTANT: If this fault is active, the gas detector is offline and not monitoring. Correct the input supply voltage to restore normal operation.

Description	Fault Code	Hex Code	Possible Causes
Critical Faults	F-09		Critical fault. Cycle power to the sensor and see if the fault clears. If not, the gas detector should be removed from service and replaced.
	:	:	
	F-15		

8.2. Diagnostics Attributes (P.-18)

Use this option to review the built-in diagnostic attributes. Access the parameter list (see Section 5) and select P.-18. Press the Enter button to access the diagnostics, and then use the UP or DOWN button to select each attribute. The following information is available.

Table 19: Diagnostic Attributes

Attribute	Description
A-01	Displays the current fault condition code in hex format: 0000 = no faults are active XXXX = HEX number See Table 18 for the HEX format cross reference.
A-02	Displays a hex format code that corresponds to any faults that occurred since the internal fault record was last erased. See Table 18 for the HEX format cross reference. The records may be erased by pressing the ENTER button.
A-03	Displays the number of days that the MGS-250 has been in service. The value of this attribute rolls over after 9999.
A-04	Displays the elapsed time (in days) from the last gas adjustment or test. This value is automatically reset to 0000 after completing a gas adjustment via Test Mode P.-17. (Note that the new adjustment is stored using the Enter button.) The value may be reset to 0000 by pressing the ENTER button.

Attribute	Description
A-05	<i>Reserved</i>
:	
A-07	
A-08	Displays the sensor temperature in °C.
A-09	Displays the sensor's approximate rate of temperature change per half minute interval (°C change over 30 seconds).
A-10	<i>Reserved</i>
:	
A-11	

8.3. Resetting MGS-250 to Default Values

The gas detector may be reset to its default state, if needed, to aid in troubleshooting. All settings, including alarm setpoint, gas adjustments, selected gas curve, calibration data, Modbus address, etc. revert to specific default values after a reset. The broadband sensor option (P/N 6401-0500) resets to gas group 1. Gas specific products (P/Ns 6401-0501 through 6401-0514) are reset to the R134a gas curve.



IMPORTANT: Calibrations on either gas-specific or broadband models are lost after a reset. This returns the gas detector to an uncalibrated condition. See parameter P.-17 for information on how to recalibrate the gas detector.

Before performing this operation it is advisable to write down all the parameter settings, so they can be re-programmed.

Step	Description
1	Access diagnostics menu P.-18.
2	Press and hold both the UP and DOWN buttons for 5 seconds. This will cause the following to occur: <ul style="list-style-type: none"> All the LED segments will then light for 3 seconds The gas detector resets to the default settings The gas detector beeper sounds for 3 seconds.
3	After 3 seconds the user is returned to the parameter list at parameter P.-18.
4	The gas detector may now be re-programmed for further troubleshooting if needed.

8.4. Other Symptoms

Other common wiring problems can also cause the gas detector to malfunction. Check below for additional conditions that will cause gas detector issues.

Table 20: Other Symptoms and Possible Causes

Symptom	Possible Cause(s)
Green power LED off	Check power supply. Check wiring.
Alarms in the absence of a leak	If you experience alarms in the absence of a leak, try setting an alarm delay. Perform a bump test to ensure proper operation.

Section 9. Replacement Parts and Accessories

The following items are available as replacement parts.



NOTE: All modules come ready to mount to the original mounting base provided.

Table 21: Replacement Parts and Accessories

Part Number	Description
0051-2320	Calibration Gas Regulator, 1.0 LPM, 5/8"-18 UNF fitting
6400-0014	Mounting Base Kit (with Mounting Hardware)
6400-0015	Gas Detector Module, Broadband ¹
6400-0016	Gas Detector Module, R22 Calibrated ¹
6400-0017	Gas Detector Module, R123 Calibrated ¹
6400-0018	Gas Detector Module, R134a Calibrated ¹
6400-0019	Gas Detector Module, R404a Calibrated ¹
6400-0020	Gas Detector Module, R407a Calibrated ¹
6400-0021	Gas Detector Module, R407c Calibrated ¹
6400-0022	Gas Detector Module, R407f Calibrated ¹
6400-0023	Gas Detector Module, R410a Calibrated ¹
6400-0024	Gas Detector Module, R422a Calibrated ¹
6400-0025	Gas Detector Module, R422d Calibrated ¹
6400-0026	Gas Detector Module, R427a Calibrated ¹
6400-0027	Gas Detector Module, R507 Calibrated ¹
6400-0028	Gas Detector Module, HFO1234YF Calibrated ¹
6400-0029	Gas Detector Module, HFO1234ZE Calibrated ¹
6490-9000	Installation and Operation Manual
6900-0001	Splash Shield Kit (Accessory): Provides additional protection for wash down or impact. Includes mounting hardware for attaching to walls. NOTE: The gas detector response time will lengthen when the splash shield is used. The installer is responsible for determining whether the response time is suitable for the application.

1 – Replacement gas detector modules do not include the mounting base (order P/N 6400-0014)

CE DECLARATION OF CONFORMITY

The manufacturer of the products covered by this declaration:	Bacharach, Inc. 621 Hunt Valley Circle New Kensington, PA 15068
Year conformity is declared:	2013
Product(s):	Refrigerant Gas Monitor/Transmitter
Model(s):	MGS-250

The undersigned hereby declares that the above referenced products are in conformity with the provisions of the following standard(s) and is in accordance with the following directive(s).

Directive(s):

2004/108/EC	Electromagnetic Compatibility (EMC) Directive
2006/65/EC	Low Voltage Directive (LVD)

Standard(s):

EN 50270:2006	Electromagnetic compatibility – electrical apparatus for the detection and measurement of combustible gases, toxic gases or oxygen
EN 55011:2007	Limits and methods of measurement of electromagnetic disturbance characteristics of industrial, scientific and medical (ISM) radio frequency equipment
IEC 61010-1:2010 EN 61010-1:2010	Safety requirements for electrical equipment for measurement, control, and laboratory use – Part 1: General requirements

Signature:

Name: Aaron Kennison
Title: Engineering Manager
Date: 3 July 2013

The technical documentation file required by this directive is maintained at the corporate headquarters of Bacharach, Inc.



Murco - A Bacharach Company
114a George's Street LOWER
Dun Laoghaire • Co Dublin • IRELAND
Phone: +353 1 284 6388 • Fax: +353 1 284 6389
www.murcogasdetection.com • sales@murco.ie



World Headquarters
621 Hunt Valley Circle, New Kensington, Pennsylvania 15068
Phone: 724-334-5000 • Toll Free: 1-800-736-4666 • Fax: 724-334-5001
Website: www.MyBacharach.com • E-mail: help@MyBacharach.com

